



SOSEN LED Driver, Your Smart Choice

Specifications

SS-150VP Series LED Driver

Model: SS-150VP-XX

Description: 150W LED Driver

Rev.: V00

Release Date: 2019-07-26

SS-150VP Series LED Driver

SOSEN
LED DRIVER



LED DRIVER

VP Series



Features:

- Efficiency up to 92%
- DIM: DALI, 0-10V,PWM,Resistor,Timing
- Dim-to-Off
- Surge protection: L/N-PE: 10kV, L-N: 6kV
- Optional aux : 12V/0.2A
- Constant lumen, life warning
- PS-ON signal
- External NTC to protect LED module
- No load power<0.5W
- IP67
- Communication function with PC
- TYPE HL, suitable for hazard locations
- Protections: SCP/OTP
- Warranty: 8 years



Description:

SS-150VP series are constant current driver for outdoor LED . With wide operating windows and current adjustability. LED luminaries manufactures can easily to design luminaries and reduce luminaries manufactures cost.

Application:

High bay light, stadium light, plant light, fish light

Model List:

Model	AC Input Range	Max. Pout	Vout Range	Full Power Working Voltage	Iout	THD(Typ.)	PF(Typ.)	Eff.(Typ.)	Max. Tc
SS-150VP-56*	90-305Vac	150W	22-56V	36-56V	0.35-4.2A	8%	0.95	91%	90°C
SS-150VP-143*	90-305Vac	150W	72-143V	100-143V	0.35-1.5A	8%	0.95	92%	90°C
SS-150VP-215*	90-305Vac	150W	108-215V	143-215V	0.1-1.05A	8%	0.95	92%	90°C

SS-150VP Series LED Driver

“*” Means Additional Function

“*”	DALI (suffix D)	AUX 12V (suffix H)	NTC (suffix N)	0-10V/PWM Dim /Timing (suffix B)	Remark
BH		✓		✓	
BHN		✓	✓	✓	
DH	✓	✓			
DHN	✓	✓	✓		

Input Characteristics:

Parameter	Min.	Typ.	Max.	Remark
Rated AC Input Range	100Vac		277Vac	
AC Input Range	90 Vac		305Vac	
Input Frequency Range	47Hz	50/60Hz	63Hz	
Max Input Current			1.8A	100Vac, full load
Max Input Power			180W	100Vac, full load
Max Input Current(120Vac)			100A	Cold Start
Max Input Current(220Vac)			125A	Cold Start
Max Input Current(277Vac)			150A	Cold Start
Standby Power			0.5W	220Vac/50Hz, Light short circuit
Power Factor	0.95	0.97		220Vac/50Hz, full load
	0.90			100-277Vac/50Hz, 70-100% load
THD		8%	10%	220Vac/50Hz, full load
			20%	100-277Vac/50Hz, 70-100% load

SS-150VP Series LED Driver

Output Characteristics(SS-150VP-56*):

Parameter	Min.	Typ.	Max.	Remark
Output Voltage Range	22V		56V	Power Derated @22-36V
Rated Output Voltage	36V		56V	$P_o=V_o \cdot I_o=150W$, full load
Rated Output Current	2.7A		4.2A	4.2A for 36V, 2.7A for 56V
Current Adjustable Range(AOC)	0.35A		4.2A	By Programming
No Load Voltage			60V	
Efficiency @120Vac	87.0%	88.0%		Output 36V/4.2A
Efficiency @220Vac	90.5%	91.5%		Output 36V/4.2A
Efficiency @277Vac	91.0%	92.0%		Output 36V/4.2A
Output Current Tolerance	-5%		+5%	
Output Current Ripple(PK-AV)		5%	10%	
Start-up Current Overshoot			10%	Full load
Start-up Time			0.5S	120Vac
			0.5S	220Vac
Line Regulation	-2%		+2%	Full load
Load Regulation	-2%		+2%	
Temperature Coefficient	-0.03%/°C		+0.03%/°C	Tc:0°C~90°C
OTP	90°C	100°C	110°C	Tc, Self-recovery, o/p power decreases when the Tc increases.
Short Circuit Protection/OCP			10W	Driver will not be damaged, Hiccup mode

SS-150VP Series LED Driver

Output Characteristics(SS-150VP-143*):

Parameter	Min.	Typ.	Max.	Remark
Output Voltage Range	72V		143V	Power Derated @72-100V
Rated Output Voltage	100V		143V	$P_o=V_o \cdot I_o=150W$, full load
Rated Output Current	1.05A		1.5A	1.5A for 100V, 1.05A for 143V
Current Adjustable Range(AOC)	0.35A		1.5A	By Programming
No Load Voltage			160V	
Efficiency @120Vac	89.0%	90.0%		Output 143/1.05A
Efficiency @220Vac	91.0%	92.0%		Output 143/1.05A
Efficiency @277Vac	91.0%	92.0%		Output 143/1.05A
Output Current Tolerance	-5%		+5%	
Output Current Ripple(PK-AV)		5%	10%	
Start-up Current Overshoot			10%	Full load
Start-up Time			0.5S	120Vac
			0.5S	220Vac
Line Regulation	-2%		+2%	Full load
Load Regulation	-2%		+2%	
Temperature Coefficient	-0.03%/°C		+0.03%/°C	Tc:0°C~90°C
OTP	90°C	100°C	110°C	Tc, Self-recovery, o/p power decreases when the Tc increases.
Short Circuit Protection/OCP			10W	Driver will not be damaged, Hiccup mode

SS-150VP Series LED Driver

Output Characteristics(SS-150VP-215*):

Parameter	Min.	Typ.	Max.	Remark
Output Voltage Range	108V		215V	Power Derated @108-143V
Rated Output Voltage	143V		215V	$P_o=V_o \cdot I_o=150W$, full load
Rated Output Current	0.7A		1.05A	1.05A for 143V,0.7A for 215V
Current Adjustable Range(AOC)	0.1A		1.05A	By Programming
No Load Voltage			230V	
Efficiency @120Vac	89.0%	90.0%		Output 215/0.7A
Efficiency @220Vac	91.0%	92.0%		Output 215/0.7A
Efficiency @277Vac	91.0%	92.0%		Output 215/0.7A
Output Current Tolerance	-5%		+5%	
Output Current Ripple(PK-AV)		5%	10%	
Start-up Current Overshoot			10%	Full load
Start-up Time			0.5S	120Vac
			0.5S	220Vac
Line Regulation	-2%		+2%	Full load
Load Regulation	-2%		+2%	
Temperature Coefficient	-0.03%/°C		+0.03%/°C	Tc:0°C~90°C
OTP	90°C	100°C	110°C	Tc, Self-recovery, o/p power decreases when the Tc increases.
Short Circuit Protection/OCP			10W	Driver will not be damaged, Hiccup mode

SS-150VP Series LED Driver

Other Characteristics:

Parameter		Min.	Typ.	Max.	Remark
Aux Power	12V	11.8V	12.6V	13.2V	
	12V	0mA		200mA	
0-10V Dimming (Optional, DIM current<30mA)	Dim Vcc	0V		12V	Negative dimming by programming
	Dim Range	10%I _o set		100%I _o set	Internal constant current supply current approximately 110μA
	Rec.Dim Range	1V		10V	
PWM Dimming (Optional)	PWM High	9.8V		10.2V	Negative dimming by programming
	PWM Low	0V		0.3V	Internal constant current supply current approximately 110μA
	Frequency	1KHz		2KHz	
	PWM Duty	10%		100%	
Resistor Dimming (Optional)	Resistance	10K		100K	Negative dimming by programming
	Dim Range	10%		100%	Internal constant current supply current approximately 110μA
Dim to Off (Optional)	Dim-off	3%	5%	7%	By DC voltage, PWM, resistance dimming ratio
	Dim Turn on	5%	7%	9%	By DC voltage, PWM, resistance dimming ratio
Timing Curve(Optional)		By programming			Set by program
DALI Dimming(Optional)		Meet DALI2.0			
Constant Lumen(Optional)		By programming			Set by program
Life Warning(Optional)		By programming			Set by program
Life Time(Tc≤65°C)		100,000 hours			80% Load
Life Time(Tc≤75°C)		71,000 hours			80% Load
MTBF		198,200 hours			220Vac,full load, Ta=25°C (MIL-HDBK-217F)
IP Grade		IP67			
Tc		90°C			
Warranty		8 years			Tc : 75°C, 80% Load
Net Weight		1000g			
Dimension		209mm*71mm*39.6mm 8.23in*2.8in*1.56in			L x W x H

NOTE: 1,All the parameters above are tested Ta 25°C, unless specified.

2. When using resistor dimming (parallel connection of dimming wires), if the number of parallels is: N, the dimming resistor should be realized 0-100% dimming range, resistance value: 91KΩ/N.

SS-150VP Series LED Driver

Environmental Requirements

Parameter	Min.	Typ.	Max.	Remark
Operating Temperature(Tcase)	-40°C	25°C	+90°C	
Storage Temperature	-40°C	25°C	+85°C	
Operation Humidity	10%RH		90%RH	
Storage Humidity	5%RH		95%RH	
Altitude	-65m		4000m	

Safety and EMI/EMS Standards

Certification	Standard	Status	Remark
UL/CUL	UL8750	✓	
ENEC	EN 61347-2-13:2014 EN61347-1:2008+A1:2011+A2:2013 EN62493:2015		
RCM	AS/NZS61347.2.13		
CCC	GB 19510.14-2009		
CE	EN 61347-2-13:2014 EN61347-1:2008+A1:2011+A2:2013	✓	
KC	K61347-1,K61347-2-13		

EMI/EMS	Criterion	Remark
Conduction Emission	EN55015:2013+A1:2015	
Radiation Emission	EN55015:2013+A1:2015	
Harmonic Current Emissions	IEC/EN 61000-3-2	Class C
Surge	IEC/EN61000-4-5	Difference mode 6kV, Common mode 10kV,Criterion B
Ring Wave	IEC/EN 61000-4-12	Difference mode 6kV, Common mode 6kV,Criterion B

SS-150VP Series LED Driver

Performance Curves:

Output Voltage Vs. Output Current(DIM/AOC Window)

SS-150VP-56*

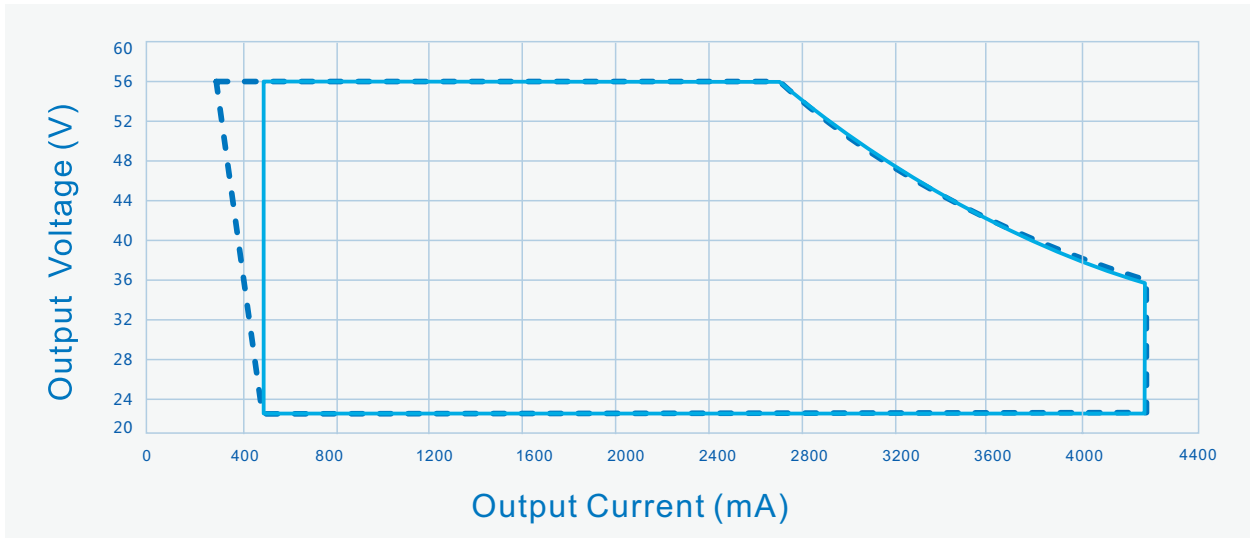

----- Diming Window

————— AOC Window

Output Voltage Vs. Output Current(DIM/AOC Window)

SS-150VP-143*

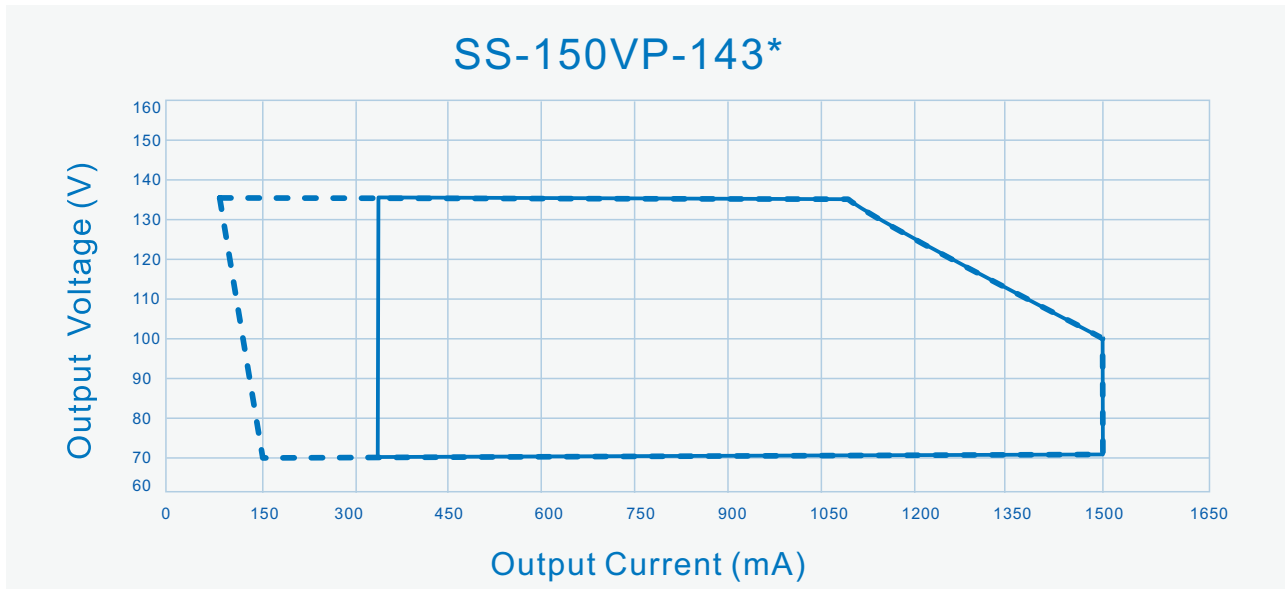

----- Diming Window

————— AOC Window

SS-150VP Series LED Driver

Performance Curves:

Output Voltage Vs. Output Current(DIM/AOC Window)

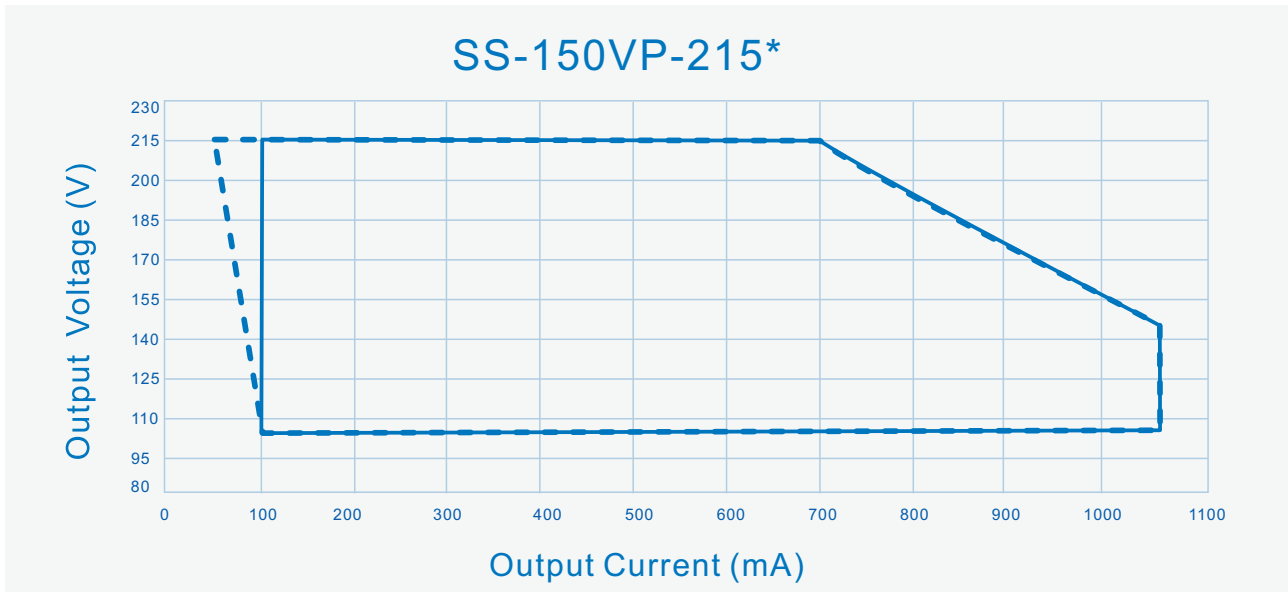

----- Diming Window

————— AOC Window

Efficiency Vs. Output Voltage (Vin=120Vac)

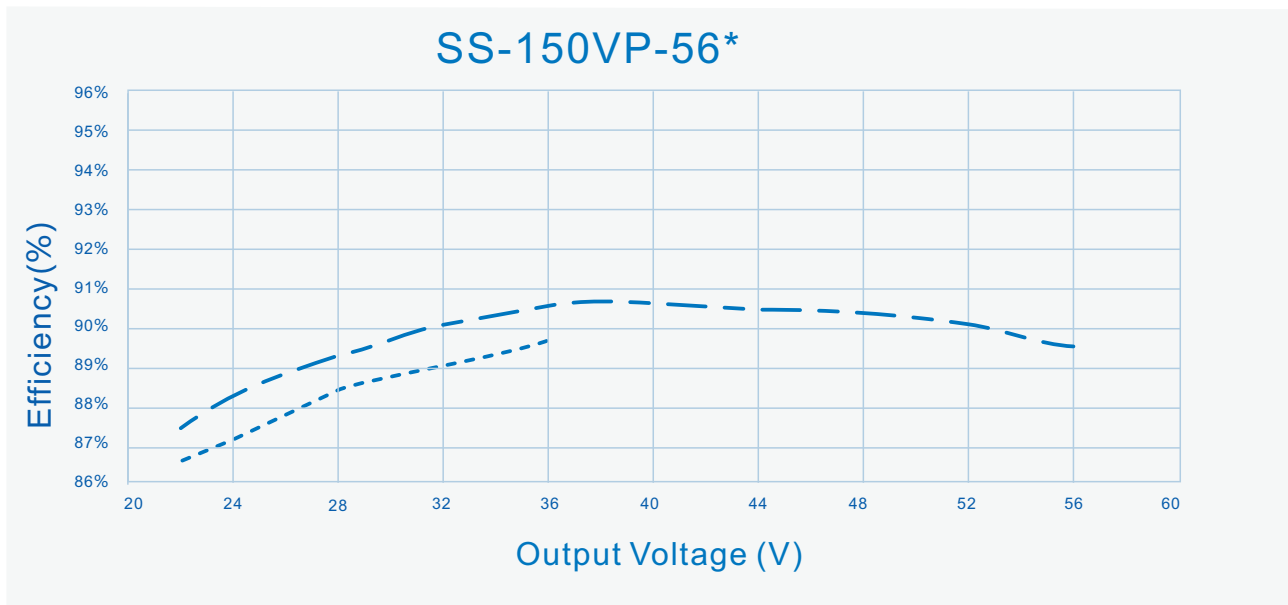

----- Io=4200mA

- - - - Io=2700mA

SS-150VP Series LED Driver

Performance Curves:

Efficiency Vs. Output Voltage ($V_{in}=220V_{ac}$)

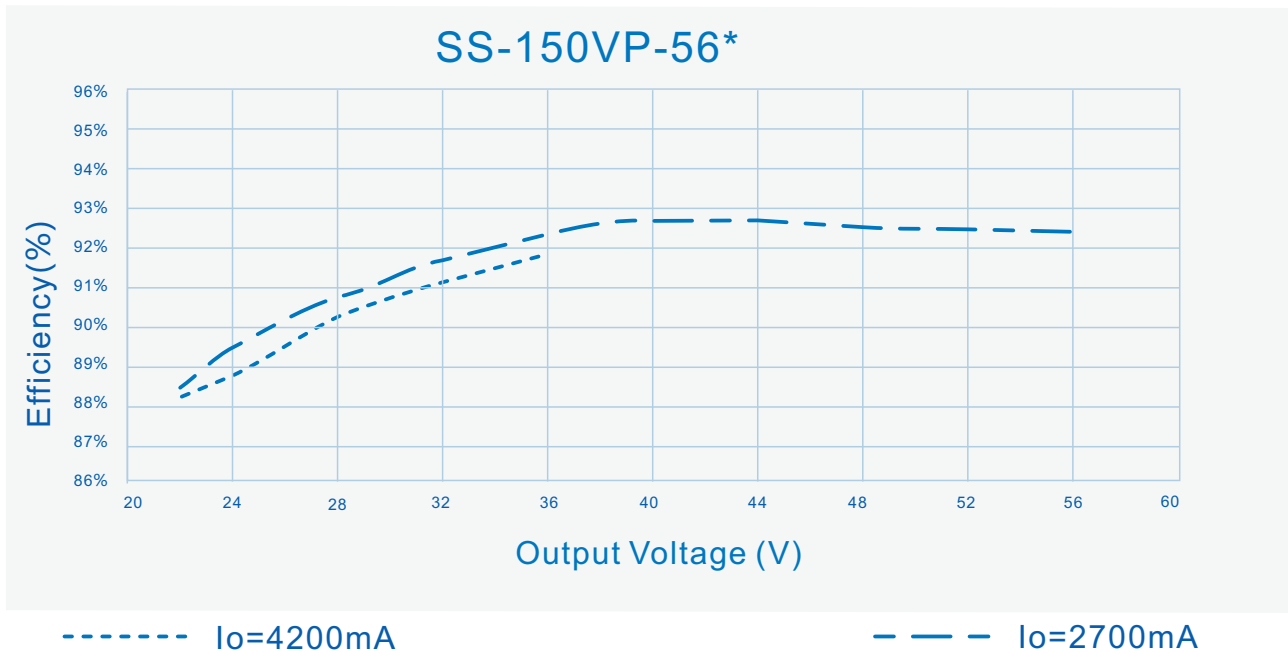

Efficiency Vs. Output Voltage ($V_{in}=277V_{ac}$)

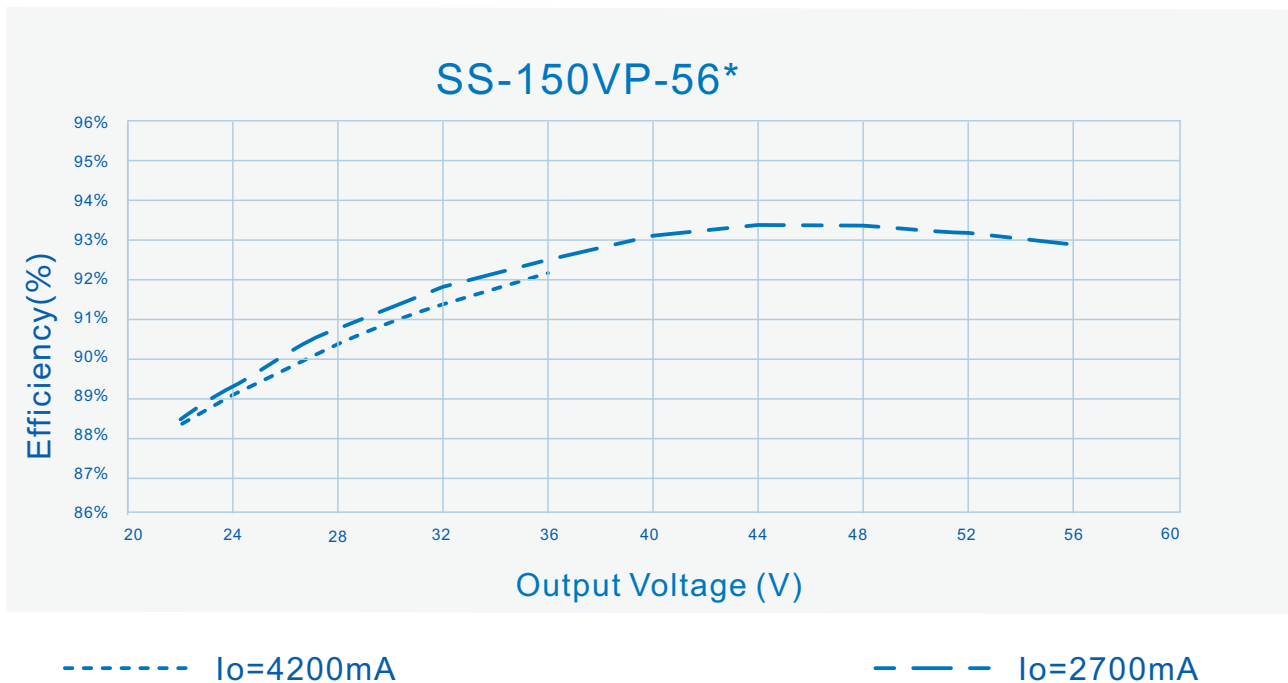

SS-150VP Series LED Driver

Performance Curves:

Efficiency Vs. Output Voltage ($V_{in}=120V_{ac}$)

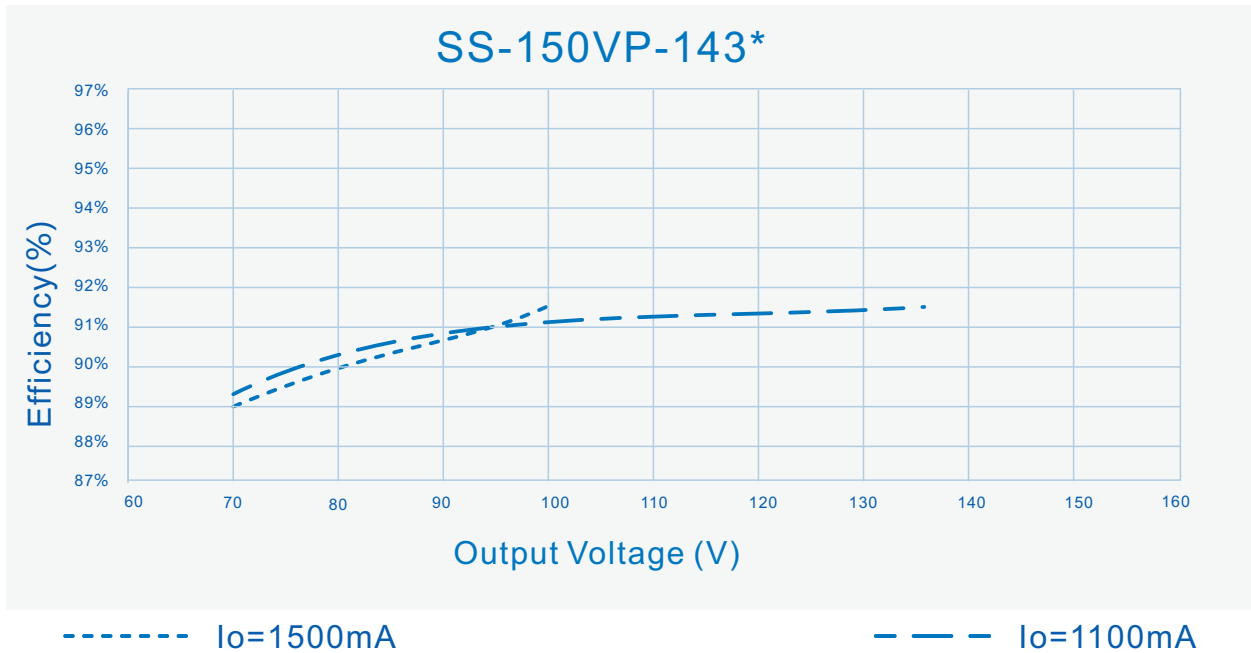

Efficiency Vs. Output Voltage ($V_{in}=220V_{ac}$)

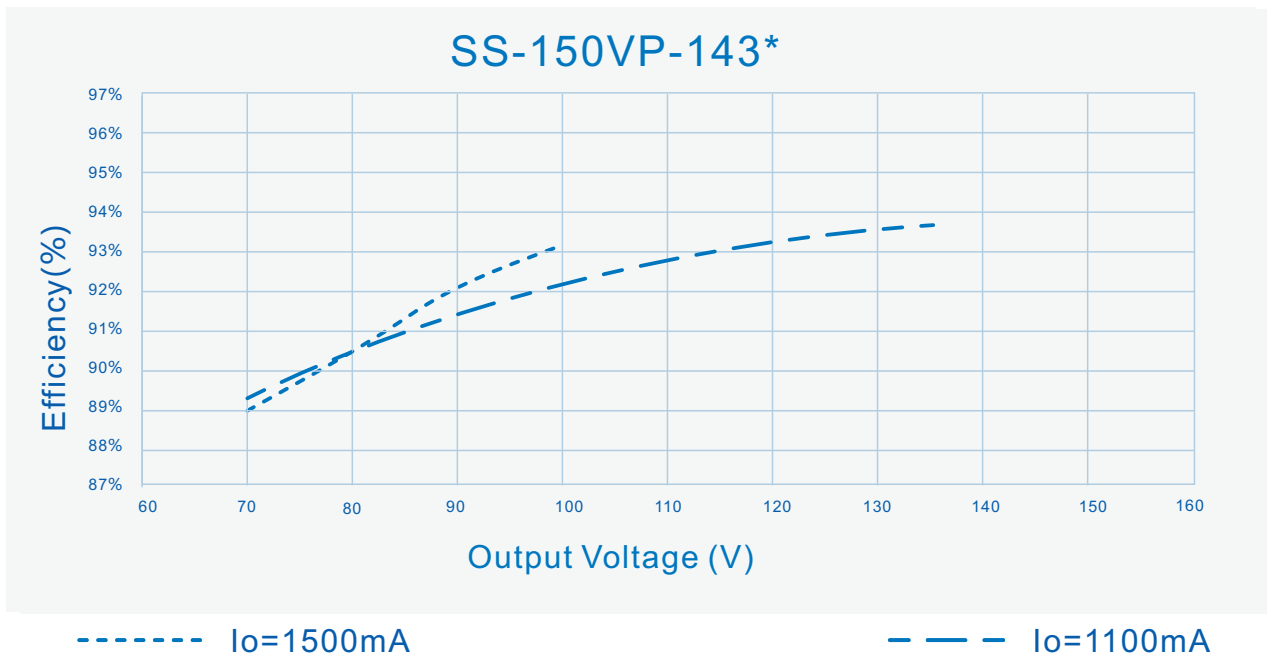

SS-150VP Series LED Driver

Performance Curves:

Efficiency Vs. Output Voltage ($V_{in}=277V_{ac}$)

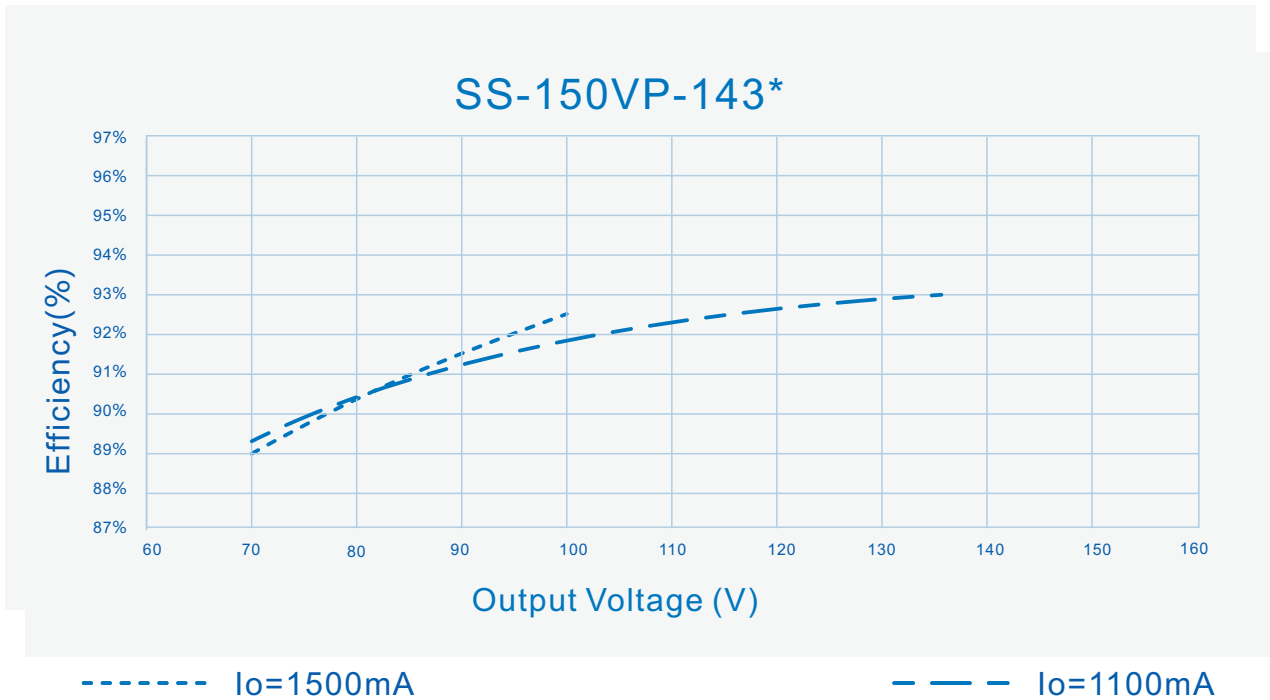

Efficiency Vs. Output Voltage ($V_{in}=120V_{ac}$)

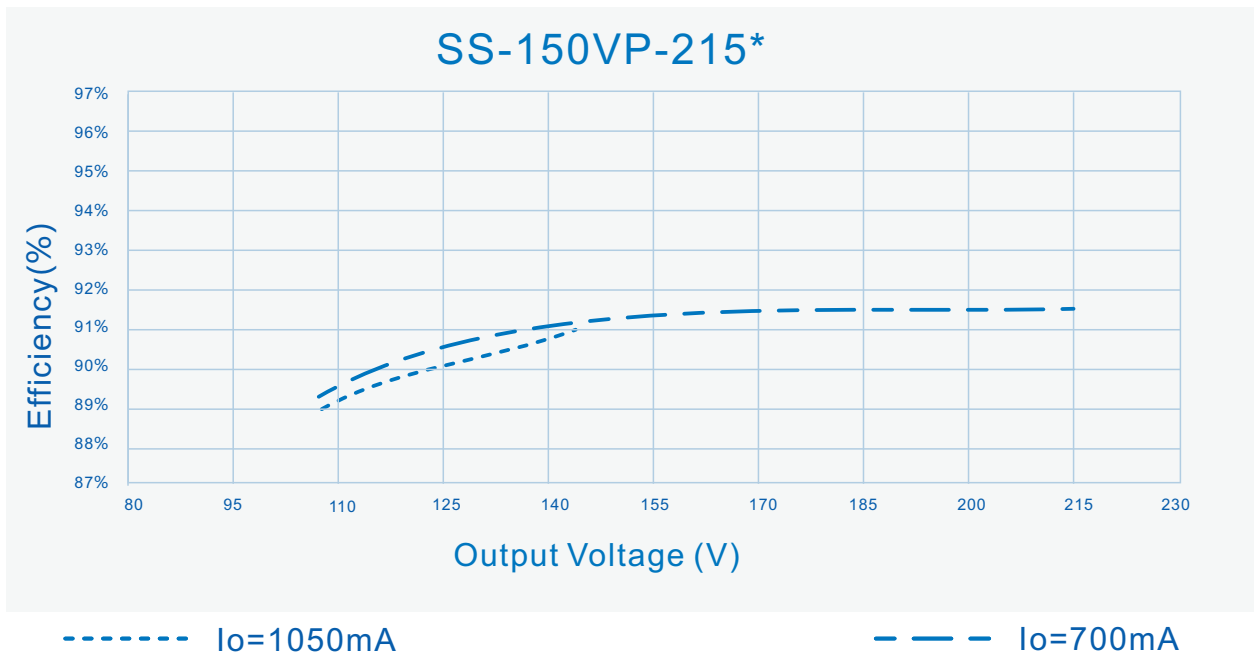

SS-150VP Series LED Driver

Performance Curves:

Efficiency Vs. Output Voltage ($V_{in}=220V_{ac}$)

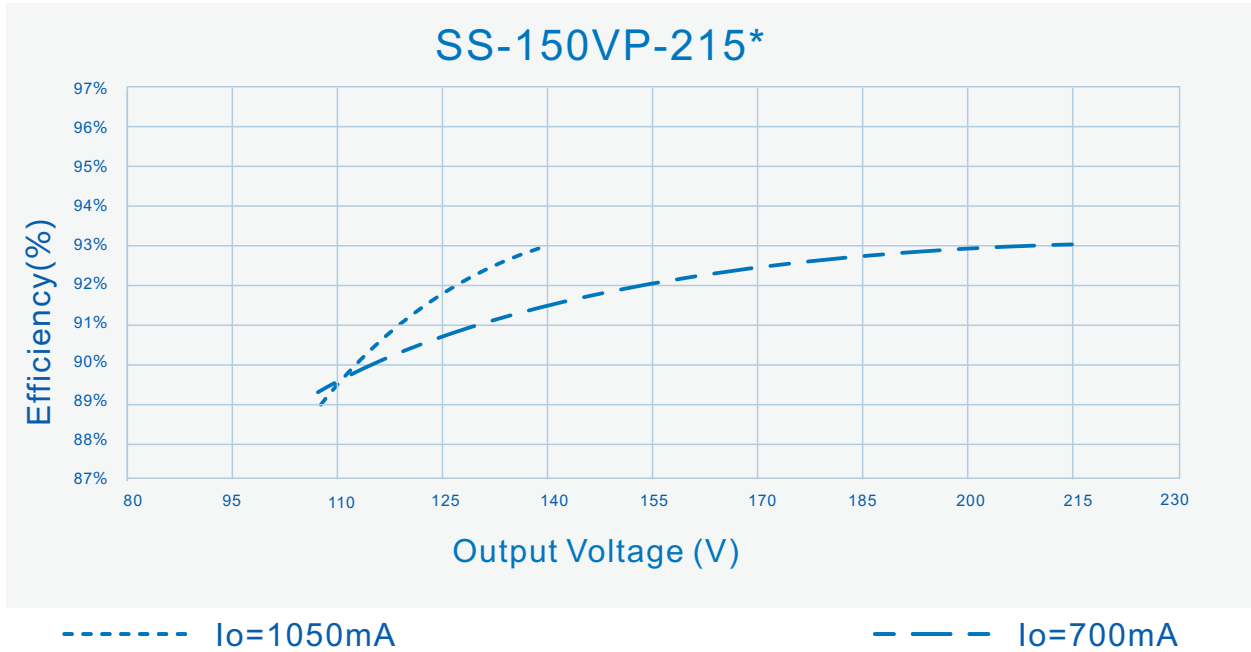

Efficiency Vs. Output Voltage ($V_{in}=277V_{ac}$)

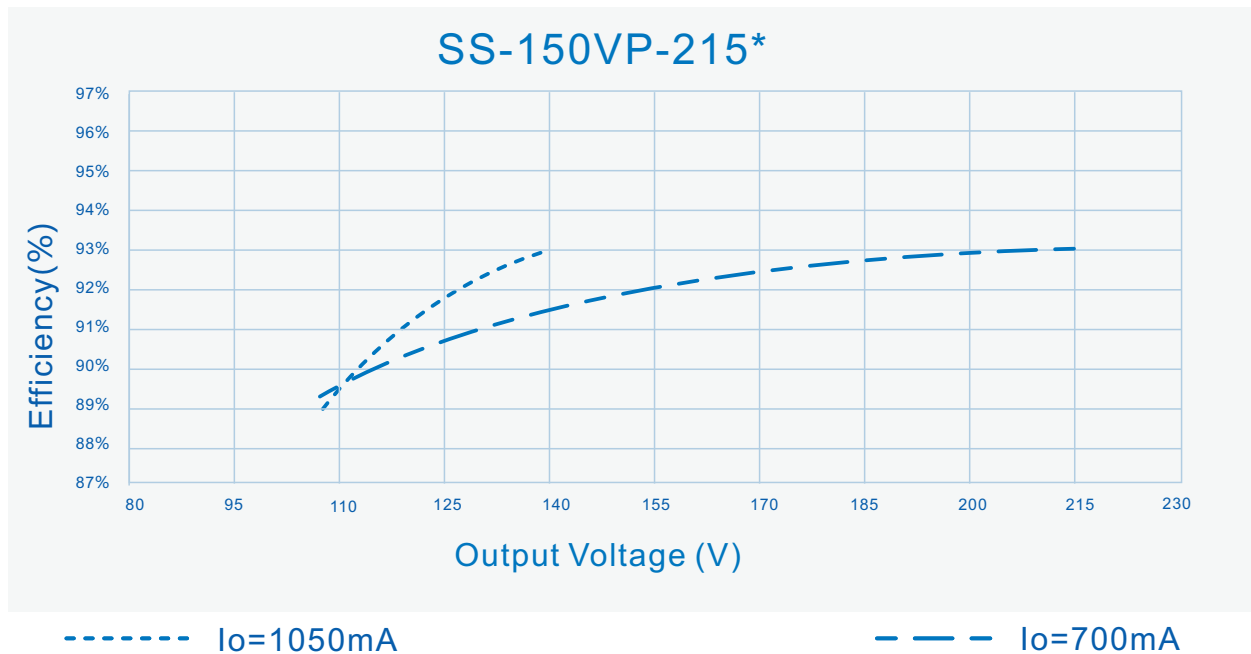

SS-150VP Series LED Driver

Performance Curves:

Power Factor Vs. Output Power

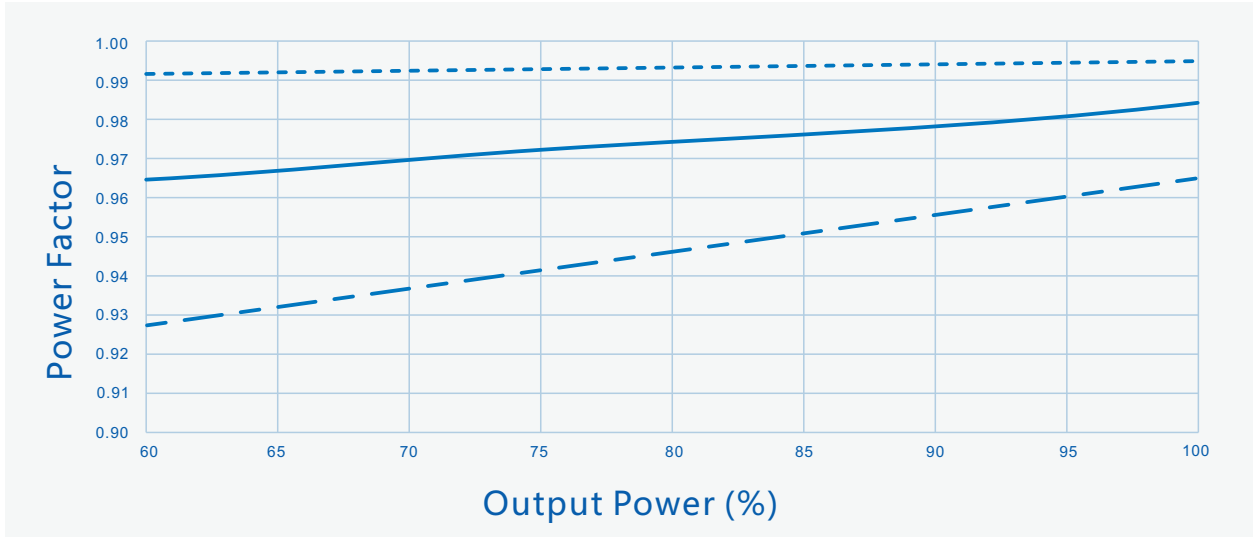

----- Vin=120Vac ————— Vin=220Vac - . - . Vin=277Vac

THD Vs. Output Power

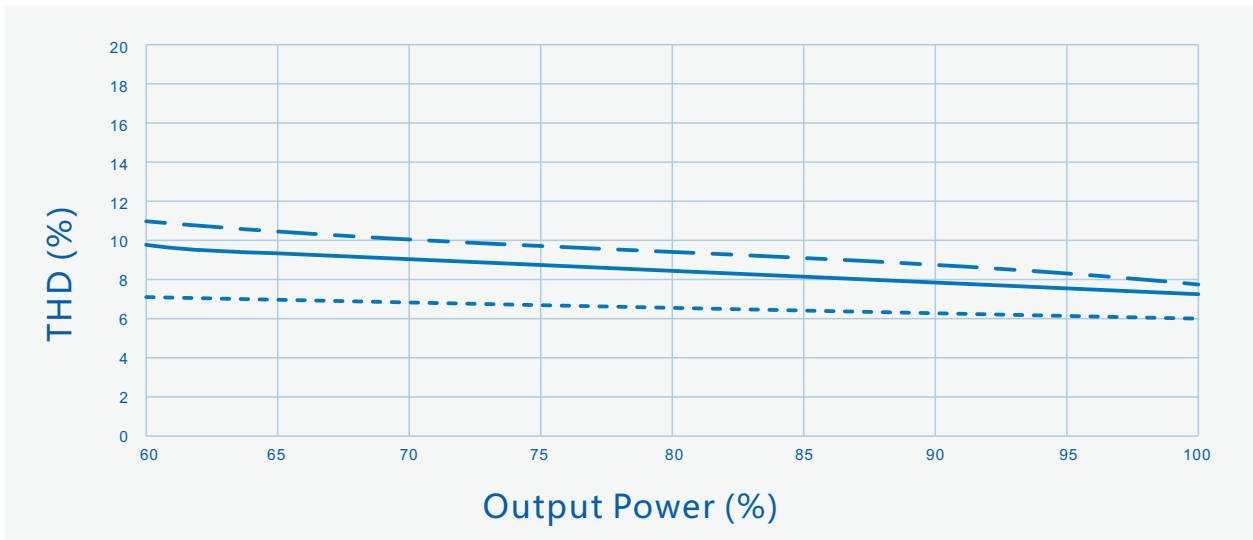

----- Vin=120Vac ————— Vin=220Vac - . - . Vin=277Vac

SS-150VP Series LED Driver

Performance Curves:

Input inrush Current

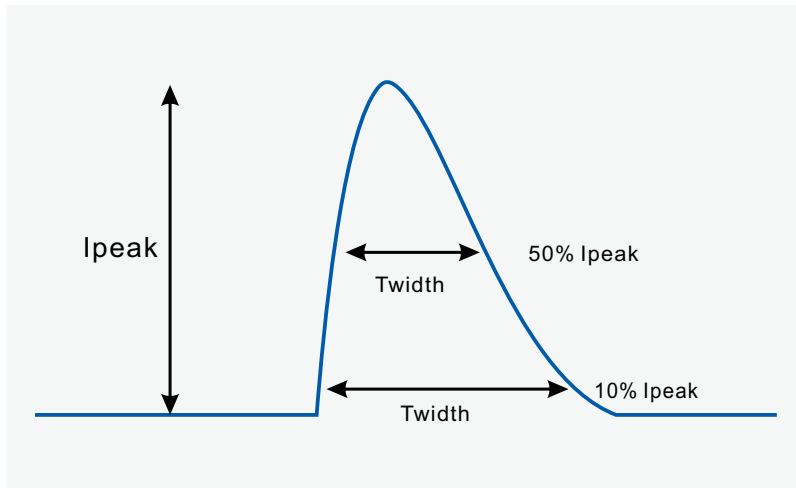

V _{in}	I _{peak}	T(@10% of I _{peak})	T(@50% of I _{peak})
120Vac	100A	120uS	
220Vac	125A		150uS
277Vac	150A	220uS	

Safety Test Items:

Safety test items	Technical Indicators			Remark
Insulation Requirements	UL Insulation Requirements	TUV Insulation Requirements	CCC Insulation Requirements	
Input-Output	1600Vac	3000Vac	3750Vac	Reinforced insulation
Input-Case	1600Vac	1500Vac	1875Vac	Basic insulation
Input-Dim	1600Vac	3000Vac	3750Vac	Reinforced insulation
Output-Dim	1600Vac	1000Vac	1000Vac	Additional insulation
Output-Case	1600Vac	1000Vac	1000Vac	Function insulation
Dim-Case	1600Vac	250Vac	250Vac	
Insulation Resistance	≥10MΩ			Input-Output, Test voltage:500Vdc
Ground Resistance	≤0.1Ω			25A/1min
Leak Current	≤0.75mA			277Vac

NOTE:

1. SOSEN warrants the LED Driver itself meets with EMC standard. However, LED Driver's EMC should be re-checked when integrated into lighting systems due to unexpected interference as component.
2. Please short Line and Neutral, LED+ and LED-, Dim+ and Dim - when Hi-pot test.

SS-150VP Series LED Driver

Performance Curves:

Output Power Vs. Input Voltage

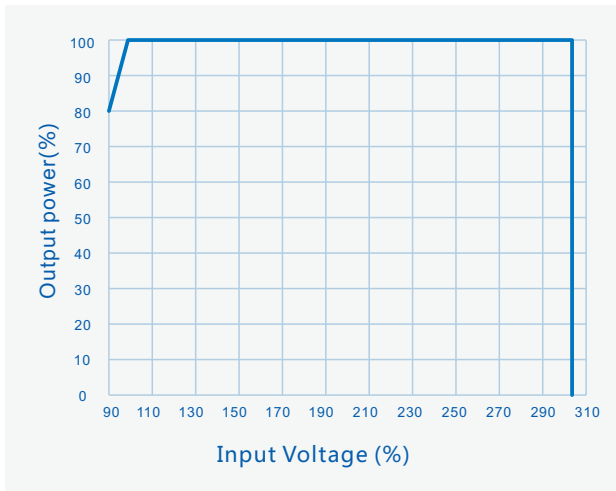

Output Power Vs. Case Temperature

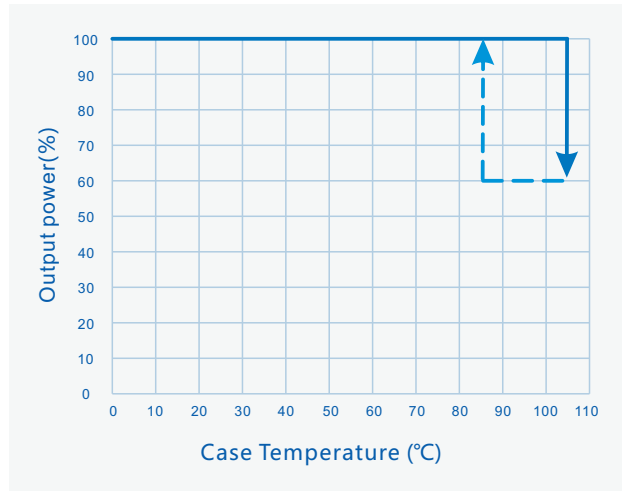

Output Power Vs. Dimming

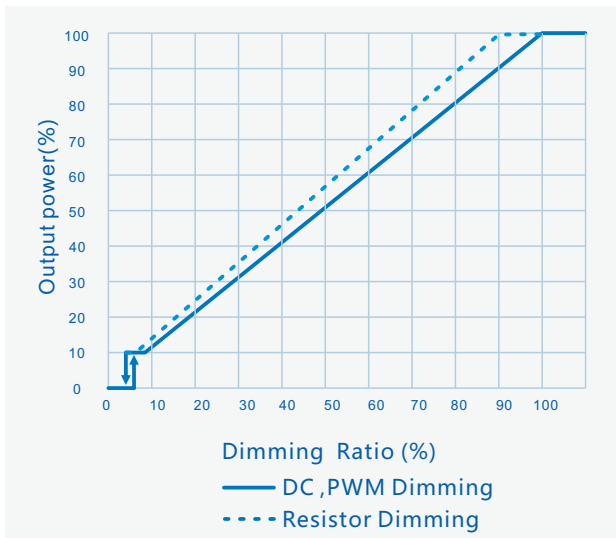

Life Time Vs. Case Temperature

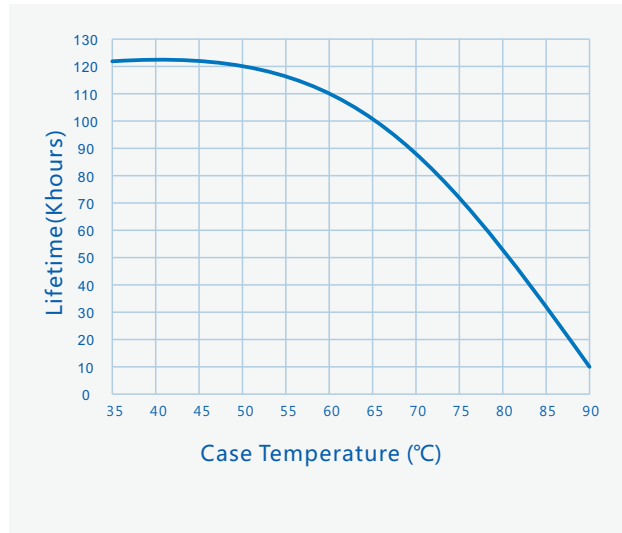

SS-150VP Series LED Driver

Constant Lumen Output

Constant Lumen Output are design to maintain fixture's stable output lumen by increasing driver's output current within driver's life span to counteract LED lumen degradation.

Programming connection diagram :

Legacy Timer: Driver's output follows the pre-programmed timing curve after turn-on.

Auto-Adjust by Percentage: Driver's output will be adjusted by automatically changed dimming curve by the period percentage based on the latest 5 dimming curve.

Auto-Adjust by Mid-point: Driver's output will be adjusted by automatically changed dimming curve by mid-point based on the latest 5 dimming curve.

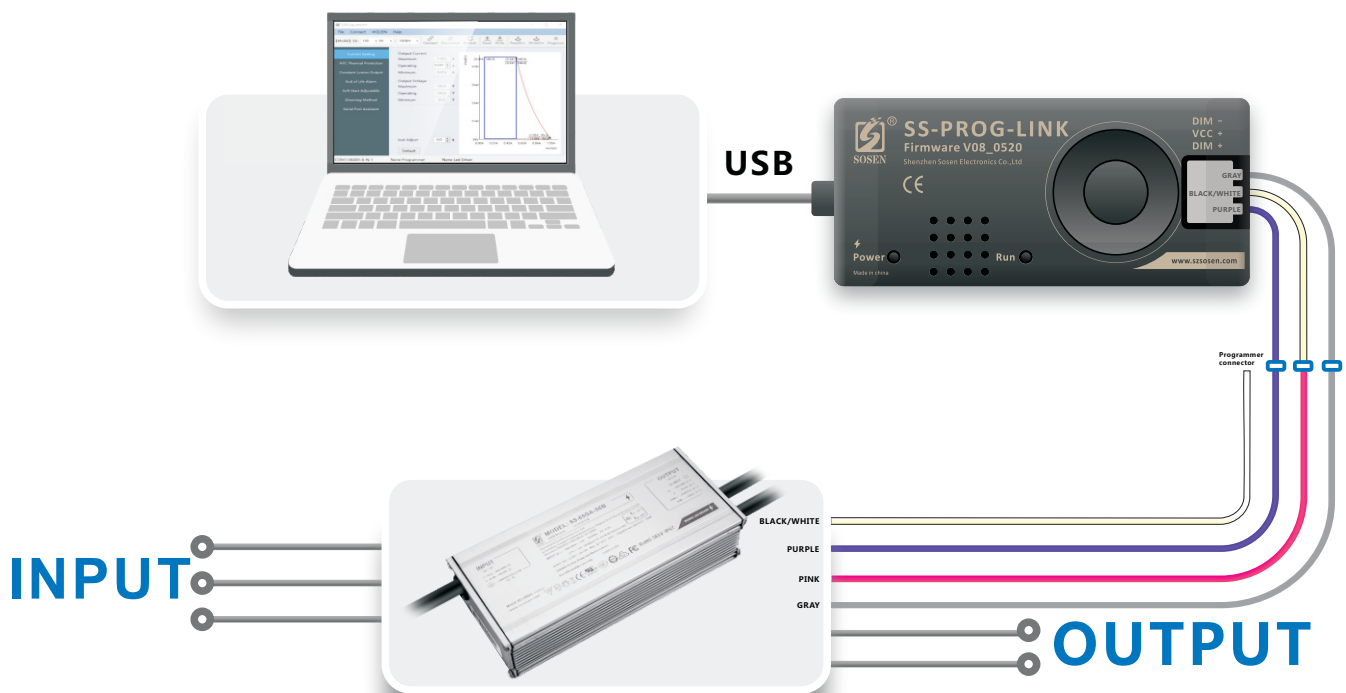

Note:

Programming could be completed by off-line mode either without turn on the driver nor without PC, other than the traditional on-line mode.

SS-150VP Series LED Driver

Mechanical Characteristics(Unit: mm/inch)

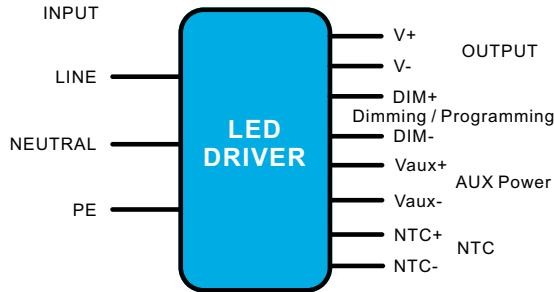

AC Input Cable(Lead Length outside enclosure 450±10mm):

Global model: SJOW,3*17AWG,O.D: 8.5mm,Brown:L,Blue:N,Yellow/Green:PE
 UL model: SJTW,3*18AWG,O.D: 7.8mm,Black:L,White:N,Green:PE

DC Output Cable(Lead Length outside enclosure 250±10mm):

Global model: SJOW,2*17AWG,O.D: 7.9mm,Brown:V+ , Blue:V-
 UL model: SJTW,2*18AWG,O.D: 7.6mm,Red: V+ , Black: V-

DIM/AUX Power/Programming Cable

(Lead Length outside enclosure 220±10mm):

UL model: 21996 4*22AWG , O.D: 5.6mm , Purple : DIM+ , Gray: DIM- ,
 Pink: VCC+ , Black/White: VCC-

NTC Cable(Lead Length outside enclosure 300±10mm):

UL model:21996 2*22AWG , O.D: 4.7mm , Blue: NTC+ , White: NTC-

Name Description	Standard Code	mm(In.)
Case Length	L3	182(7.17)
Case Width	W1	71(2.8)
Case Height	H	39.6(1.56)
Overall Length	L1	209(8.23)
Mounting Hole Length	L2	196(7.72)
Mounting Hole Width	W2	34(1.34)
TC point position	X	70(2.76)
TC point position	Y	46(1.81)

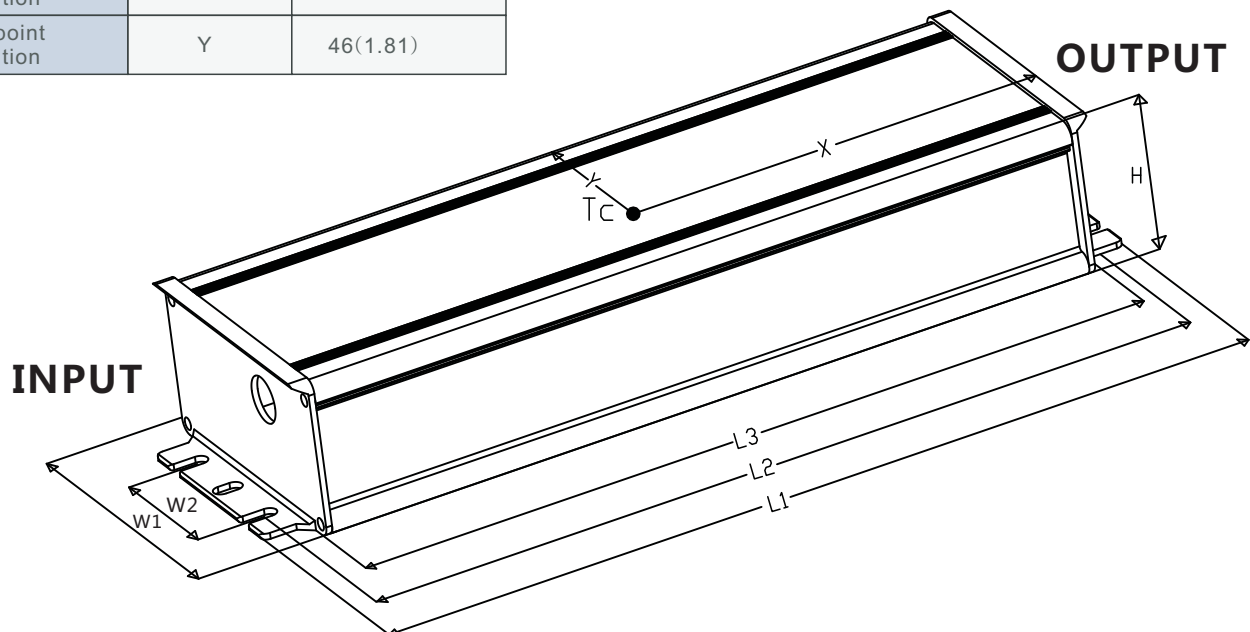

SS-150VP Series LED Driver



Installation Tips

1. Dimming leads should be capped if not in use to avoid dimming circuit damage caused by external signals.

Package

- Outside carton dimension: L×W×H =500mm×390mm×170mm;
- 14PCS/Carton;
- Net weight/PC: 1kg;Gross weight/Carton: 15kg;
- Please refer to the product name, model number, manufacturer identification, quality inspection certificate, manufacturing date Etc. on the package. and LED power supply instruction manual in the package.

Transportation

Packaging is designed suitable for transportation by trucks, vessels and flights. The products should be shielded from direct sunshine, loaded/unloaded with caution.

Storage

The product storage meets the standard of the GB 3873 - 83.
Products should be rechecked if stock for over 1 year before installation.

RoHS

Products comply with European directive 2011/65/EC.

REVISION HISTORY

Version	Description of Change	Changed Date	Remark
V00	Original release	2019/04/22	

